

42 t
RC40



SPECIFICATIONS

CRANE PERFORMANCE DATA

Capacity at 3 m from slewing axis (CE)	42 t
Boom length (retracted/extended)	9.1 / 27.4 m
Boom head height	29.5 m

TRUCK PERFORMANCE DATA ⁽¹⁾

Max. travelling speed (on 16.00R25 tyres)	34 km/h
Max. travelling speed (on 20.5R25 tyres)	33 km/h
Max. theoretical ramp during operation (on 16.00R25 tyres)	84 %
Max. theoretical ramp during operation (on 20.5R25 tyres)	87 %

(1) Standard crane in operating conditions: no auxiliary winch and no extensions

WEIGHTS ⁽²⁾

1 st axle	2 nd axle	Total
11.6 t	15.9 t	27.5 t

(2) Standard crane: no auxiliary winch and no extensions, on 16.00R25 tyres

OPERATING SPEED / TIMES ⁽³⁾

Main winch (max. speed under direct pull)	80 m/min
Auxiliary winch (max. speed under direct pull)	80 m/min
Telescopic boom lifting / lowering	65 / 35 s
Telescopic boom extension / retraction (9.1 m to 21.3 m)	70 / 30 s
Upper structure slewing	30 s
Extension of single outrigger beam	20 s
Extension of single outrigger	25 s

(3) Average reference indicative values measured at 2000 rpm of engine

TRUCK

Traction/Steering	4x4x4
Frame	With twin body side member. Front tow point (back tow point on request)
Outriggers	no. 4 independent hydraulic outriggers onto hydraulic beams. Outrigger beams can be fully retracted, partially or fully extended. Outrigger controls in the operating cab.
Engine	CUMMINS QSB6.7: no. 6 in-line cylinders - displacement: 6.7 cu dm - water cooling with intercooler - turbo supercharger – common rail. Max. power 119 kW at 2200 rpm - Max. torque 732 Nm at 1400 rpm. 2004/26/CE Step IIIA approved.
Tank	300 l
Transmission	DANA series 20000: Powershift-type transmission with torque converter. 3 + 3 forward speeds and 3 + 3 reverse speed: slow and fast speed mode. Automatic engagement of 4WD after selecting slow speed mode
Brakes	Operating brakes: double-circuit hydro-pneumatic drum brakes on all wheels. Parking / Emergency brake: negative action onto front transmission shaft. Pneumatic spring brake.
Axles	no. 2 driving / steering axles equipped with planetary gearboxes into hubs. On request, differential locks
Suspension	Stiff suspension for front axle, swinging suspension for rear axle. Rear suspension is automatically locked by hydraulic jacks if lifting boom is not aligned with centreline within front crane area. Manual stop for rear suspension locking in operating cab.
Steering	Hydrostatic steering controlled by steering wheel into the operating cab. Steering of front axle alone or both axles in concentric or crab mode.
Tyres	no. 4 16.00R25 tubeless tyres On request, no. 4 20.5R25 tubeless tyres

UPPER STRUCTURE

Boom	no. 4 octagonal elements
Lifting	no. 1 double action hydraulic jack. Boom inclination: -2° to $+78^{\circ}$
Extension	Continuous proportional extension of elements 2 and 3 through double action hydraulic jack and inner chain-driven system. Extension of element 4 through hydraulic jack by means of outer manual drift, manually locked. Extension under partial load possible.
Winch	Controlled by fixed displacement hydraulic motor equipped with axial pistons and planetary gearbox. Automatic negative brake for winch lowering. Cable tensioner. Two different rotation speeds. Rope diameter 15 mm length 175 m. Max. lifting capacity 3800 daN On request, auxiliary winch featuring same specifications as main winch. Rope diameter 15 mm length 150 m
Slewing	360° non-stop rotation controlled by hydraulic motor equipped with planetary gearbox on slewing ring having double ball ring and inner toothing. Automatic negative brake. Brake release for direct alignment of boom along load vertical line.
Operating cab	Sliding door. Wide visibility. Equipped with heating system. Front and upper window with windscreen wiper. Upper and back windows can be opened. Fully adjustable seat onto shockproof suspensions. Equipped with tiltable arm rests with integrated hand controls for crane operation.
Safety	Stop valves onto extension / lifting boom jacks and outriggers. Max. pressure valves for each hydraulic circuit. Balancing braking valve for the slewing unit. Balancing braking valve for the winch. Limit switch onto boom head for hoisting block lift. Limit switch for having three winding turns around the winch. Load limiting device with indicator for: <ul style="list-style-type: none"> Boom inclination Boom length Load weight Max. load which can be lifted <p>Telescopic boom movement limit can be set.</p>

SYSTEMS

Hydraulic system	Feeding: no. 2 double gear pumps. Movement control: distributors controlled by hydraulic hand controls. More proportional operations can be carried out at the same time. Outrigger control: solenoid valves controlled by separate buttons. Filtering: no. 1 cartridge filter in return circuit Heat exchanger for oil cooling-down
Electric system	24 V, 70 A generator and no. 2 132 Ah batteries Lighting devices in compliance with current EU directives.
Pneumatic system	247 cu cm compressor, no. 2 45 l reservoirs and drier Auxiliary air intake and tyre inflating kit

MAIN OPTIONS

Additional pulley onto boom head
Lattice extension 8 m long
Lattice extension 0.7 m + 7.3 m long
Lattice extension 0.7 m + 7.3 m + 6.0 m long
Air conditioning / heating system into operating cab
Operating kit for temperatures up to -20°C
Operating kit for temperatures up to $+45^{\circ}\text{C}$
Auxiliary winch
10 t hook block
5 t hook

Refer to your local dealer for a complete list of available options.

SPECIFICHE TECNICHE

PRESTAZIONI DELLA GRU

Portata a 3 m da asse ralla (CE)	42 t
Lunghezza braccio (chiuso / aperto)	9.1 / 27.4 m
Altezza testa braccio	29.5 m

PRESTAZIONI DEL CARRO ⁽¹⁾

Velocità massima di traslazione (con pneumatici 16.00R25) <small>(La velocità di traslazione è costruttivamente limitata a 25 km/h per la circolazione su strade pubbliche)</small>	34 km/h
Velocità massima di traslazione (con pneumatici 20.5R25) <small>(Versione non omologata per la circolazione su strade pubbliche)</small>	34 km/h
Rampa massima teorica in condizioni di marcia (con pneumatici 16.00R25)	84 %
Rampa massima teorica in condizioni di marcia (con pneumatici 20.5R25)	87 %

(1) Gru in versione standard ed in condizioni di marcia: senza argano ausiliario, senza prolungha

MASSE ⁽²⁾

I° assale	II° assale	Totale
11.6 t	15.9 t	27.5 t

(2) Gru in versione standard: senza argano ausiliario, senza prolungha, con pneumatici 16.00R25

VELOCITÀ / TEMPI DI LAVORO ⁽³⁾

Argano principale (massima in tiro diretto)	80 m/min
Argano ausiliario (massima in tiro diretto)	80 m/min
Sollevamento / Discesa braccio telescopico	65 / 35 s
Sfilo / Rientro braccio telescopico (da 9.1 m a 21.3 m)	70 / 30 s
Rotazione sovrastruttura	30 s
Sfilo singola traversa porta-stabilizzatori	20 s
Sfilo completo singolo stabilizzatore	25 s

(3) Valori medi di riferimento misurati a 2000 giri/min motore e forniti a puro titolo indicativo

CARRO

Trazione/Sterzo	4x4x4
Telaio	A doppio longherone a cassone. Punto di traino anteriore (in opzione anche posteriore)
Stabilizzatori	n. 4 idraulici indipendenti installati su travi sfilabili idraulicamente. Stabilizzazione con travi parzialmente o completamente estese. Azionamento dalla cabina di guida
Motore	CUMMINS QSB6.7: 6 cilindri in linea – Cilindrata 6.7 dm ³ - Raffreddato ad acqua con intercooler – Turbocompresso – Common rail. Potenza massima 119 kW a 2200 giri/min - Coppia massima 732 Nm a 1400 giri/min. Certificazione 2004/26/CE Fase IIIA
Serbatoio	300 l
Trasmissione	DANA serie 20000: Tipo powershift con convertitore di coppia. 3+3 marce avanti e 3+3 retromarce con selezione di gamma lenta e veloce. Inserimento automatico della trazione integrale selezionando la gamma lenta
Freni	Servizio: a doppio circuito a tamburo su tutte le ruote ad azionamento idropneumatico. Stazionamento / Emergenza: negativo sull'albero di trasmissione anteriore del tipo a molla con azionamento pneumatico
Assali	n. 2 assali motori e sterzanti con riduttori epicicloidali nei mozzi. In opzione possibilità di blocco dei differenziali
Sospensioni	Rigida su assale anteriore, oscillazione dell'assale posteriore. Blocco automatico dell'oscillazione posteriore mediante martinetti idraulici quando il braccio di sollevamento non è nel settore anteriore della gru allineato sull'asse di mezzzeria. Possibilità di blocco manuale dalla cabina dell'oscillazione posteriore.
Sterzo	Idrostatico mediante volante in cabina di guida. Possibilità di sterzata del solo assale anteriore o di entrambi in modalità concentrica o a granchio.
Pneumatici	n. 4 pneumatici 16.00R25 tubeless. In opzione n. 4 pneumatici 20.5R25 tubeless

SOVRASTRUTTURA

Braccio	n. 4 elementi a sezione ottagonale
Sollevamento	n. 1 martinetto idraulico a doppio effetto. Possibilità di inclinazione del braccio da -2° a $+78^{\circ}$
Sfilo	Gli elementi 2 e 3 sono sfilati in modo proporzionale e continuo mediante un martinetto idraulico a doppio effetto ed un sistema interno di rinvio a catene. L'elemento 4 è sfilato dal martinetto idraulico mediante puntone esterno a posizionamento manuale ed è bloccato manualmente. Possibilità di sfilo sotto carico parziale.
Argano	Azionato da motore idraulico a pistoni assiali a cilindrata fissa con riduttore epicicloidale. Freno negativo sulla discesa ad inserimento automatico. Dispositivo pressafune. Doppia velocità di rotazione. Fune diametro 15 mm lunghezza 175 m. Capacità massima di sollevamento 3800 daN. In opzione argano ausiliario avente le medesime caratteristiche di quello principale. Fune diametro 15 mm lunghezza 150 m
Rotazione	Continua su 360° mediante motore idraulico e riduttore epicicloidale su ralla a doppio giro di sfere con dentatura interna. Freno negativo ad inserimento automatico. Comando di sblocco del freno per l'allineamento diretto del braccio sulla verticale del carico da sollevare
Cabina	Ad ampia visibilità con sportello scorrevole. Dotata di riscaldamento. Vetro anteriore e superiore con tergicristallo. Vetro superiore e posteriore apribili. Sedgiolino completamente regolabile su sospensioni anti-shock, dotato di braccioli sollevabili che integrano i manipolatori per il comando dei vari movimenti della gru.
Sicurezza	Valvole di blocco sui martinetti di sfilo e sollevamento braccio e sugli stabilizzatori. Valvole di massima pressione su ogni circuito idraulico. Valvola di bilanciamento e frenatura su gruppo rotazione. Valvola di bilanciamento e frenatura sull'argano. Interruttore di fine corsa su testa braccio per la salita del bozzello. Interruttore di fine corsa per conservare tre giri di avvolgimento fune sull'argano. Dispositivo limitatore di carico con indicazione: Inclinazione braccio Lunghezza braccio Carico sollevato Massimo carico sollevabile Possibilità di impostare la limitazione dei movimenti del braccio telescopico.

IMPIANTI

Idraulico	Alimentazione: n. 2 pompe doppie ad ingranaggi. Controllo movimenti: distributori azionati da manipolatori idraulici con possibilità di manovre simultanee proporzionali. Controllo stabilizzatori: elettrovalvole azionate da pulsanti indipendenti. Filtraggio: n. 1 filtro a cartuccia sul circuito di ritorno. Scambiatore di calore per il raffreddamento dell'olio
Elettrico	a 24 V con alternatore da 70 A e n. 2 batterie da 132 Ah. Dispositivi di illuminazione conformi alle direttive dell'Unione Europea
Pneumatico	Compressore da 247 cm ³ , n. 2 serbatoi da 45 l ciascuno e dispositivo essiccatore. Presse d'aria ausiliaria e kit di gonfiaggio pneumatici





OPZIONALI PRINCIPALI



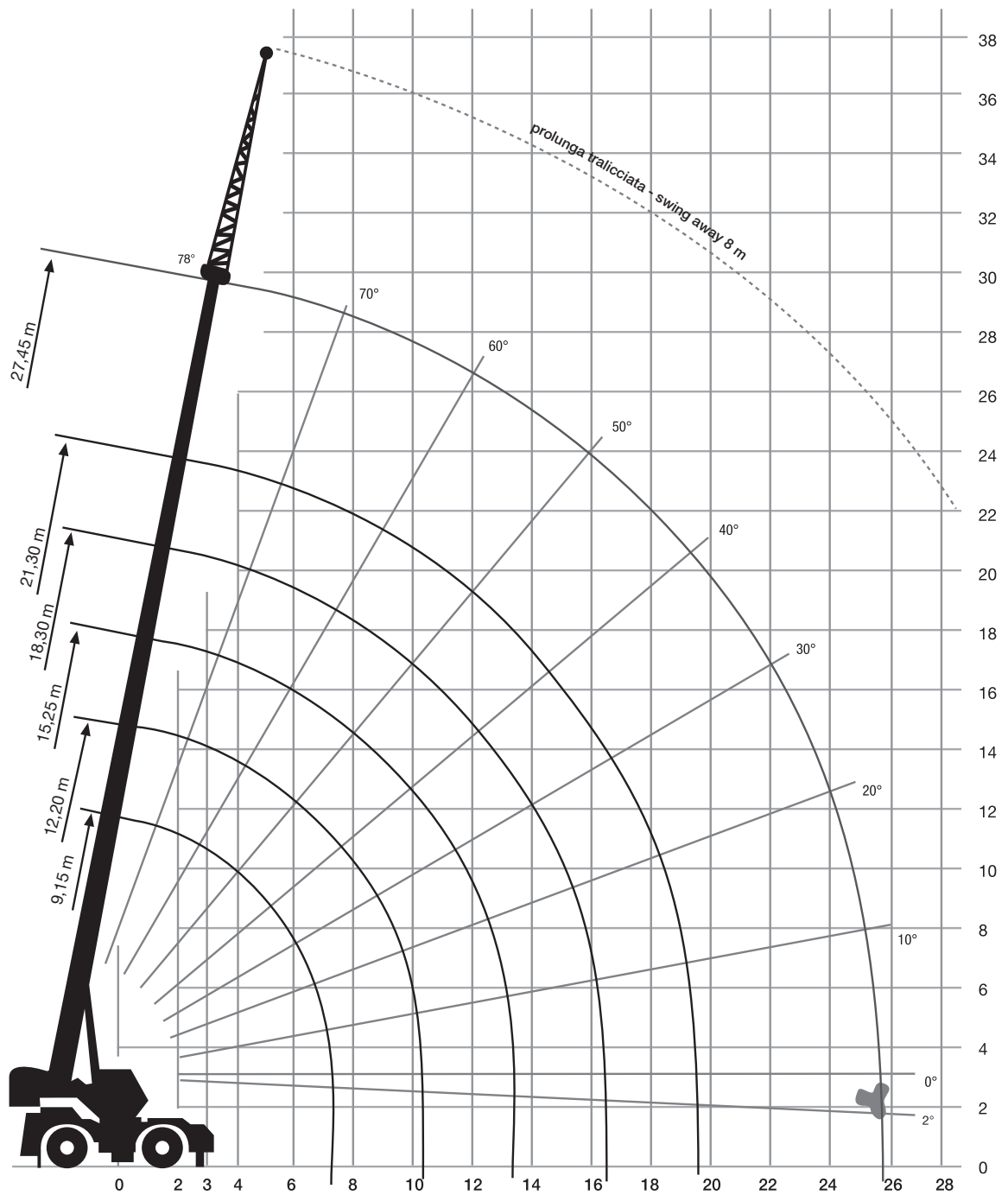
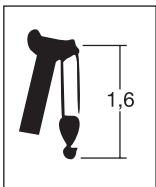
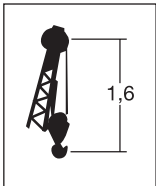
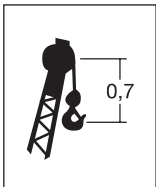







Puleggia supplementare su testa braccio
Prolunga tralicciata da 8 m
Prolunga tralicciata da 0.7 + 7.3 m
Prolunga tralicciata da 0.7 + 7.3 + 6.0 m
Impianto condizionatore caldo/freddo in cabina guida
Kit per operare fino a -20°C
Kit per operare fino a $+45^{\circ}\text{C}$
Argano ausiliario
Bozzello da 10 T
Gancio da 5 T







Riferirsi al dealer di zona per un elenco completo degli opzionali.

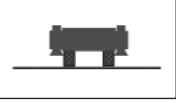

DIAGRAMMA DI LAVORO / WORKING RANGES / DIAGRAMME DE TRAVAIL / ARBEITSBEREICHE

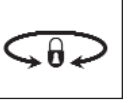
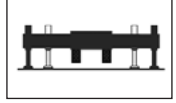

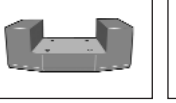







				
5.80 m	9.15 m ÷ 27.45 m	5.50 t	360°	

	t2 = 0%	t2 = 25%	t2 = 50%	t2 = 75%	t2 = 100%	t2 = 100%	
	t3 = 0%	t3 = 25%	t3 = 50%	t3 = 75%	t3 = 100%	t3 = 100%	
	t4 = 0%	t4 = 0%	t4 = 0%	t4 = 0%	t4 = 0%	t4 = 100%	
	9.15 m	12.20 m	15.25 m	18.30 m	21.35 m	27.45 m	
							
3.0	42.00	26.10	23.90	22.45			3.0
3.5	36.90	27.65	24.90	22.20	12.00		3.5
4.0	31.90	29.00	24.40	20.40	11.45		4.0
4.5	26.30	26.10	22.70	19.00	10.90	13.70	4.5
5.0	24.60	23.60	21.30	17.80	10.35	12.65	5.0
6.0	19.40	19.60	18.90	15.60	9.80	10.95	6.0
7.0	14.50	14.75	14.80	13.90	9.25	9.40	7.0
8.0		11.35	11.40	11.45	8.75	8.25	8.0
9.0		9.05	9.15	9.25	7.75	7.40	9.0
10.0		7.40	7.50	7.50	6.95	6.65	10.0
11.0			6.25	6.30	6.30	6.00	11.0
12.0			5.30	5.35	5.35	5.45	12.0
13.0			4.50	4.55	4.60	5.00	13.0
14.0				3.90	3.90	4.40	14.0
15.0				3.40	3.40	3.85	15.0
16.0				2.90	2.90	3.40	16.0
17.0					2.55	3.05	17.0
18.0					2.20	2.70	18.0
19.0					1.90	2.40	19.0
20.0						2.15	20.0
21.0						1.90	21.0
22.0						1.70	22.0
23.0						1.50	23.0
24.0						1.35	24.0
25.0						1.20	25.0

							
16.00R25/20.5R25	2 Km/h	0°	5.8 m	9.15m ÷ 27.45m	5.5 t	360°5	8.00 m ÷ 14 m

	t2 = 0%	t2 = 25%	t2 = 50%	t2 = 75%	t2 = 100%		
	t3 = 0%	t3 = 25%	t3 = 50%	t3 = 75%	t3 = 100%		
	t4 = 0%	t4 = 0%	t4 = 0%	t4 = 0%	t4 = 0%		
	9.15 m	12.20 m	15.25 m	18.30 m	21.35 m		
	3.0	42.00	26.10	23.90	22.45	3.0	
	3.5	36.90	27.65	24.90	22.20	12.00	3.5
	4.0	31.90	29.00	24.40	20.40	11.45	4.0
	4.5	26.30	26.10	22.70	19.00	10.90	4.5
	5.0	24.60	23.60	21.30	17.80	10.35	5.0
	6.0	19.40	19.60	18.90	15.60	9.80	6.0
	7.0	14.50	14.75	14.80	13.90	9.25	7.0
	8.0		11.35	11.40	11.45	8.75	8.0
	9.0		9.05	9.15	9.25	7.75	9.0
	10.0		7.40	7.50	7.50	6.95	10.0
	11.0			6.25	6.30	6.30	11.0
	12.0			5.30	5.35	5.35	12.0
	13.0			4.50	4.55	4.60	13.0
	14.0				3.90	3.90	14.0
	15.0				3.40	3.40	15.0
	16.0				2.90	2.90	16.0
	17.0					2.55	17.0
	18.0					2.20	18.0
	19.0					1.90	19.0
	20.0						20.0
21.0						21.0	
22.0						22.0	
23.0						23.0	
24.0						24.0	
25.0						25.0	

L + 8.0m 0°		L + 8.0m 20°		L + 14.0m 0°		L + 14.0m 20°	
							
Max	5.00	Max	2.40	Max	2.40	Max	1.10
78°		78°		78°		78°	
77°	5.00	78°	2.40	75°	2.40	77°	1.10
75°	4.20	76°	2.30	73°	2.20	74°	1.05
74°	4.10	74°	2.25	70°	2.00	70°	1.00
72°	4.00	72°	2.20	67°	1.80	67°	0.95
70°	3.80	71°	2.15	64°	1.60	64°	0.90
68°	3.50	69°	2.10	61°	1.40	61°	0.85
67°	3.20	67°	2.05	58°	1.30	57°	0.80
65°	3.00	65°	2.00	55°	1.20	53°	0.75
63°	2.80	63°	1.95	51°	1.10	50°	0.70
61°	2.65	62°	1.90	47°	1.00		
59°	2.50	60°	1.85	44°	0.90		
58°	2.35	58°	1.80				
56°	2.20	56°	1.75				
54°	2.10	53°	1.70				
52°	2.00	51°	1.65				
49°	1.90	49°	1.60				
47°	1.70	47°	1.55				
45°	1.60	44°	1.40				
43°	1.45	42°	1.30				
40°	1.30	39°	1.15				
38°	1.15	36°	1.00				
35°	1.05	33°	0.85				
32°	0.90	29°	0.75				
29°	0.80	25°	0.65				
25°	0.70	19°	0.55				
21°	0.60	11°	0.45				
16°	0.55						
8°	0.45						
0.0	0.40	0.0	0.40	0.0	0.40	0.0	0.40

Outriggers fully extended Stabilisateurs en extension totale Stabilizzatori completamente estesi Voll ausgefahrene Abstützungen	Outriggers half-extended Stabilisateurs en extension partielle Stabilizzatori parzialmente estesi Teilweise ausgefahrene	Outriggers unextended Stabilisateurs fermés Stabilizzatori chiusi Eingefahrene Abstützungen	Load capacity on wheels Charges sur pneus Portate su pneumatici Tragfähigkeit auf Reifen	Traveling speed Vitesse de translation Velocità traslazione Bewegungsgeschwindigkeit
Telescopic boom Flèche télescopique Braccio telescopico Teleskoparm	Counterweight Contrepoids Contrappeso Gegengewicht	Upperstructure angle rotation Angle rotation structure du dessus Angolo rotazione sovrastruttura Drehwinkel des Strukturaufbaus	Upperstructure rotation lock Blocage rotation structure du dessus Rotazione sovrastruttura bloccata Bolzen des Strukturaufbaus	Extension / Jib Extension / Jib Prolunga / Jib Verlängerung / Jib

TAGLIE DI SOLLEVAMENTO / HOIST REEVING / MOUFLAGE / HUBROLLEN

N° di taglie / No. of line Nbr. de brins / Seilanzahl	1	2	3	4	5	6	7	8	9	10	11
--	---	---	---	---	---	---	---	---	---	----	----

ARGANO PRINCIPALE / MAIN WINCH / TREUIL PRINCIPAL / HAUPTWINDE

Carico massimo in kN / Max line pull in kN Charges maxi en kN / Höchstlast in kN	38	76	114	152	190	228	266	304	342	380	418
---	----	----	-----	-----	-----	-----	-----	-----	-----	-----	-----

ARGANO AUSILIARIO / AUXILIARY WINCH / TREUIL AUXILIAIRE / ZUSATZWINDE

Carico massimo in kN / Max line pull in kN Charges maxi en kN / Höchstlast in kN	38	76	114	152	190	228	266	304	342	380	418
---	----	----	-----	-----	-----	-----	-----	-----	-----	-----	-----

NOTE

I carichi indicati costituiscono i valori massimi coperti dalla garanzia del costruttore per utilizzo rispettivamente secondo le norme della Unione Europea (CE). Sono espressi in tonnellate metriche ed includono il peso del bozzello, delle eventuali prolunghe applicate al braccio e di tutti gli accessori di sollevamento (brache, ecc.) Le operazioni di sollevamento nella configurazione su gomme devono essere effettuate su superficie piana e solida con la corretta pressione di gonfiaggio degli pneumatici e con l'oscillazione dell'assale posteriore bloccata qualora l'operazione non avvenga con braccio entro un settore di +/- 3° rispetto all'asse di mezzeria della autogrù. Le operazioni di traslazione con carico possono avvenire esclusivamente con braccio allineato all'asse di mezzeria della autogrù, perno di bloccaggio meccanico della rotazione della sovrastruttura inserito e avendo cura di mantenere il carico stesso in prossimità della autogrù senza oscillazioni

NOTES

The indicated loads are the maximum covered by the manufacturer's warranty for a use which complies with current EU directives (CE). Weights are given in metric tons. They include the weight of the block, all extensions fitted to the boom and all lifting accessories (slings and so on). Crane on wheels: operate the crane on a steady flat surface when hoisting loads and inflate tyres at proper pressure value. Also stop rear axle swinging if the load cannot be lifted having the arm within a +/- 3° sector to the crane centreline. The load can be travelled only if the boom is aligned with the crane centreline, the shaft for upper structure rotation stop is fitted and the load is kept close to the crane and is not swinging.

NOTES

Les charges indiquées constituent les valeurs maximales couvertes par la garantie du fabricant pour une utilisation conforme aux normes de l'Union Européenne. Elles sont exprimées en tonnes métriques et comprennent le poids de la moufle, des éventuelles extensions appliquées à la flèche et de tous les accessoires de levage (élingues, etc.). Les opérations de levage dans la configuration sur pneus doivent être effectuées sur une surface plane et solide avec une pression de gonflage des pneus correcte et l'oscillation de l'essieu arrière bloquée si l'opération n'a pas lieu avec la flèche située dans une zone de +/- 3° par rapport à l'axe de moitié du camion-grue. Les opérations de translation avec charge ne peuvent être effectuées qu'avec flèche alignée dans l'axe de moitié du camion-grue, goujon de blocage mécanique de la rotation de la structure du dessus enclenché et en prenant soin de maintenir la charge à proximité du camion-grue sans oscillations.

HINWEISE

Die angegebenen Lasten sind die Grenzwerte, für welche die Herstellergarantie bei Einsatz gemäß den Normen der Europäischen Union (EU). Die Grenzwerte sind in Meter-tonnen ausgedrückt, das Gewicht des Blocks, eventueller am Ausleger angebrachter Verlängerungen und jeglicher Hebezubehörteile (Schlingen usw.) ist inbegriffen. Hebearbeiten mit bereiftem Kran müssen auf einer ebenen und festen Oberfläche erfolgen; die Reifen müssen richtig befüllt und die Hinterachse festgestellt sein, wenn der Ausleger außerhalb eines Bereichs von +/- 3° im Verhältnis zur Mittelachse des fahrbaren Krans gehoben wird. Transportarbeiten mit belastetem Ausleger sind ausschließlich erlaubt, wenn der Ausleger an der Mittelachse des Krans angereicht ist, der mechanische Verriegelungszapfen, der die Drehung des Oberwagens verhindert, eingerastet ist und die Last ohne zu schwingen in Nähe des Krans behalten wird.

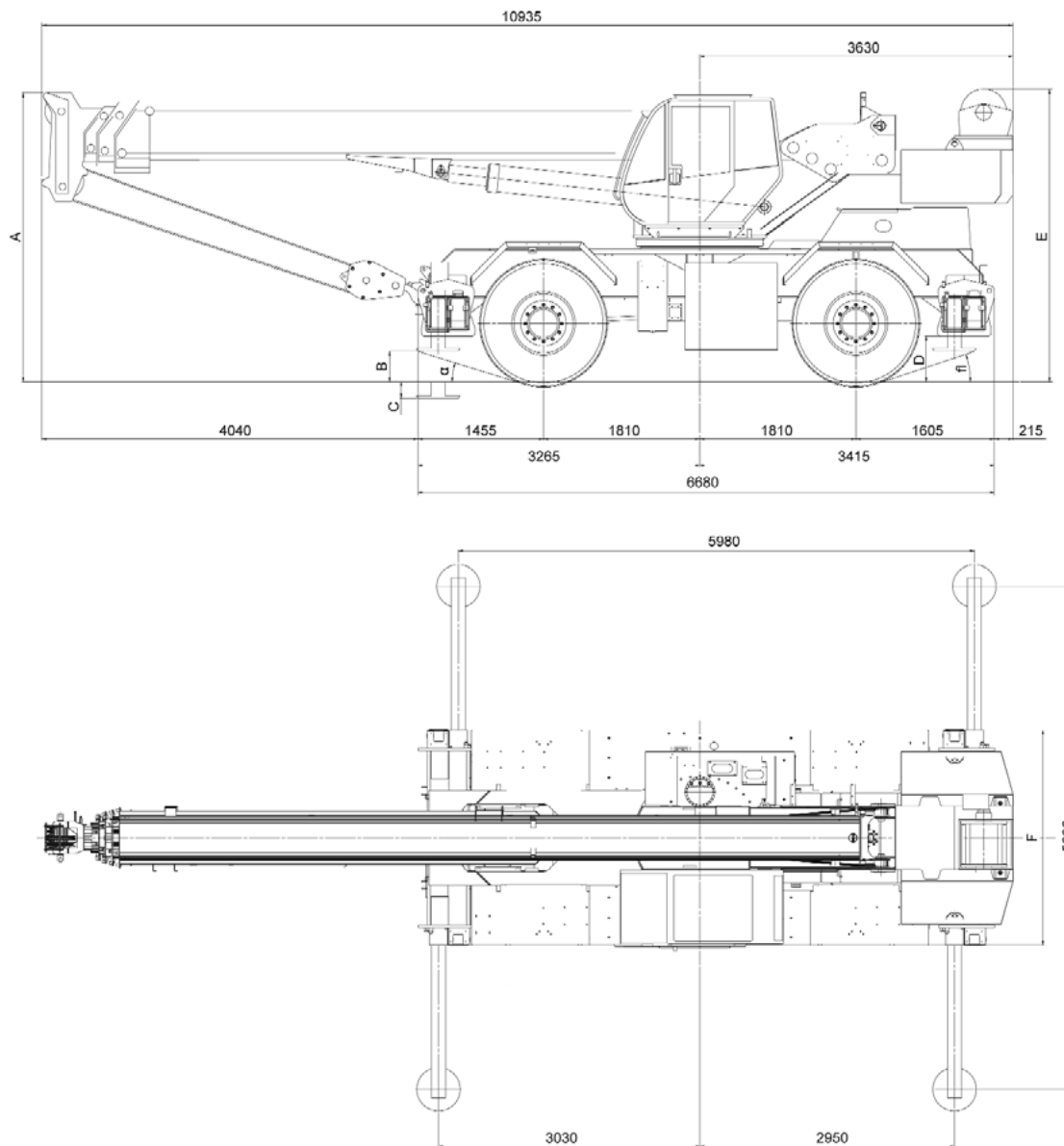

DIMENSIONI / DIMENSIONS / DIMENSIONS / ABMESSUNGEN ⁽⁴⁾

Pneumatici / Tyres Pneumatiques / Reifen	A	E	C	B	D	F	α	β
16.00R25	3323	3390	190	360	410	2550	21°	20°
20.5R25	3318	3385	195	355	405	2670	21°	20°

(4) Dimensioni medie di riferimento fornite a puro titolo indicativo. Valori espressi in millimetri
(4) Average reference values, which are indicative only. Values are expressed in mm

(4) Dimensions moyennes de référence fournies à titre purement indicatif. Valeurs exprimées en millimètres
(4) Durchschnittsmaße; dienen ausschließlich als Richtwerte. Die Werte sind in Millimetern ausgedrückt

NOTE	NOTES	NOTES	HINWEISE
<p>Ci riserviamo il diritto di modificare le specifiche e i prezzi dei prodotti in ogni momento e senza preavviso. Le fotografie e/o i disegni contenuti in questo documento sono destinati unicamente a scopi illustrativi. Consultare le istruzioni sull'uso corretto di questo macchinario contenute nell'opportuno Manuale d'uso. L'inottemperanza delle istruzioni contenute nel Manuale d'uso del macchinario e altri comportamenti irresponsabili possono provocare gravi lesioni, anche mortali. L'unica garanzia applicabile ai nostri macchinari è la garanzia scritta standard applicabile al particolare prodotto e alla particolare vendita; Terex è esonerata dal fornire qualsiasi altra garanzia, esplicita o implicita. I prodotti e servizi elencati possono essere dei marchi di fabbrica, marchi di servizio o nomi commerciali di TEREX Corporation e/o società affiliate negli Stati Uniti d'America e altre nazioni e tutti i diritti sono riservati. "TEREX" è un marchio registrato di Terex Corporation negli USA e molti altri Paesi. Copyright © 2007 Terex Corporation.</p>	<p>Product specifications and prices are subject to change without notice or obligation. The photographs and/or drawings in this document are for illustrative purposes only. Refer to the appropriate Operations Manual for instructions on the proper use of this equipment. Failure to follow the appropriate Operations Manual when using our equipment or to otherwise act irresponsibly may result in serious injury or death. The only warranty applicable to our equipment is the standard written warranty applicable to the particular product and sale and Terex makes no other warranty, express or implied. Products and services listed may be trademarks, service marks or trade-names of Terex Corporation and/or its subsidiaries in the USA and other countries. All rights are reserved. Terex® is a registered trademark of Terex Corporation in the USA and many other countries. Copyright 2007 Terex Corporation.</p>	<p>Les spécifications et prix des produits sont sujets à modification sans avis ou obligation. Les photographies et/ou dessins contenus dans ce documents sont uniquement pour illustration. Veuillez vous référer à la notice d'utilisation appropriée pour les instructions quant à l'utilisation correcte de cet équipement. Tout manquement au suivi de la notice d'utilisation appropriée lors de l'utilisation de notre équipement ou tout acte autrement irresponsable peut résulter en blessure corporelle sérieuse ou mortelle. La seule garantie applicable à notre équipement est la garantie standard écrite applicable à un produit et à une vente spécifique. Terex n'offre aucune autre garantie, expresse ou implicite. Les produits et services proposés peuvent être des marques de fabrique, des marques de service ou des appellations commerciales de Terex Corporation et/ou ses filiales aux Etats Unis et dans les autres pays, et tous les droits sont réservés. "TEREX" est une marque déposée de Terex Corporation aux Etats Unis et dans de nombreux autres pays. Copyright 2007 Terex Corporation.</p>	<p>Produktbeschreibungen und Preise können jederzeit und ohne Verpflichtung zur Ankündigung geändert werden. Die in diesem Dokument enthaltenen Fotos und /oder Zeichnungen dienen rein anschaulichen Zwecken. Anweisungen zur ordnungsgemäßen Verwendung dieser Ausrüstung entnehmen Sie bitte dem zugehörigen Betriebshandbuch. Nichtbefolgung des Betriebshandbuchs bei der Verwendung unserer Produkte oder anderweitig fahrlässiges Verhalten kann zu schwerwiegenden Verletzungen oder Tod führen. Für dieses Produkt wird ausschließlich die entsprechende, schriftlich niedergelegte Standardgarantie gewährt. Terex leistet keinerlei darüber hinaus gehende Garantie, weder ausdrücklich noch stillschweigend. Die Bezeichnungen der aufgeführten Produkte und Leistungen sind gegebenenfalls Marken, Service-marken oder Handelsnamen der Terex Corporation und/oder ihrer Tochtergesellschaften in den USA und anderen Ländern. Alle Rechte vorbehalten. "TEREX" ist eine eingetragene Marke der Terex Corporation in den USA und vielen anderen Ländern. Copyright 2007 Terex Corporation.</p>

